

PERFEKTLIGHT

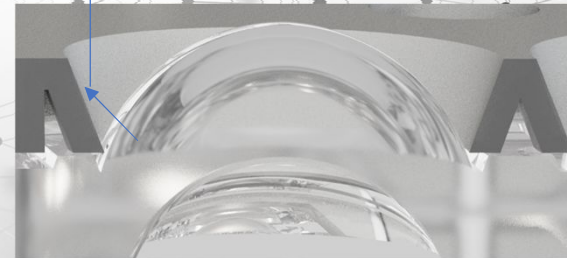

# CORUNDUM HIGHBAY

## 55-190W



## 7-year Better reliability

Stable 7-year warranty at ta55°C

## UGR < 19@60°

Professional anti-glare design, UGR < 19 optiona

## 5050 LED applications

Professional higher light Efficiency higher power 5050 LED applications

## Reliable protection

IP66 Ingress Protection; IK08 Collision grade

## Corrosion resistance

Optional 1000h salt spray test (acid or alkaline environment optional)

## Tempered glass lens

Tempered glass lens have more than 95% transmission and never turn yellow, also easier to clean

## ERP class A

ERP class A maximum energy savings

## 100,000 hours lifetime

5050 LED and driver have 100,000 hours lifetime

## Power selectable

One sku selectable six powers

## D4I intelligent control

Independent D4I power supply

## Various accessories

Bracket、 reflector、 wire guard、 Zhaga with motion sensor、 5W3H EM andother

## Order Combo

Series	Power	CCT	BeamAngle	DIM	Voltage	CRI	Finish	Mounting	Sensor	Accessory
BT-CORUNDUM	55W	4000K	120°	0-10V DALI 2.0	100-277Vac 220-240Vac	Ra80	Gray White Black	Rope Hanging Pendant Surface Mount	Motion sensor *	PR * AR
	80W									
	110W									
	135W	5000K								
	165W									
	190W									

## Order Combo

Model No.	Power	CCT	LPW	Lumens	Remarks
BT-CM190U-ACS 调功率版本	190W	4000K	185	35000lm	1. MWS and PIR sensors are available, and the maximum installation height is 12m. 2. PR/AR: Aluminum reflector for 55-190W
	165W			30000lm	
	135W	25000lm			
	110W	20000lm			
	80W	15000lm			
	55W	10000lm			

Above test results are based on initial stage and with AC230V input.

## Accessories

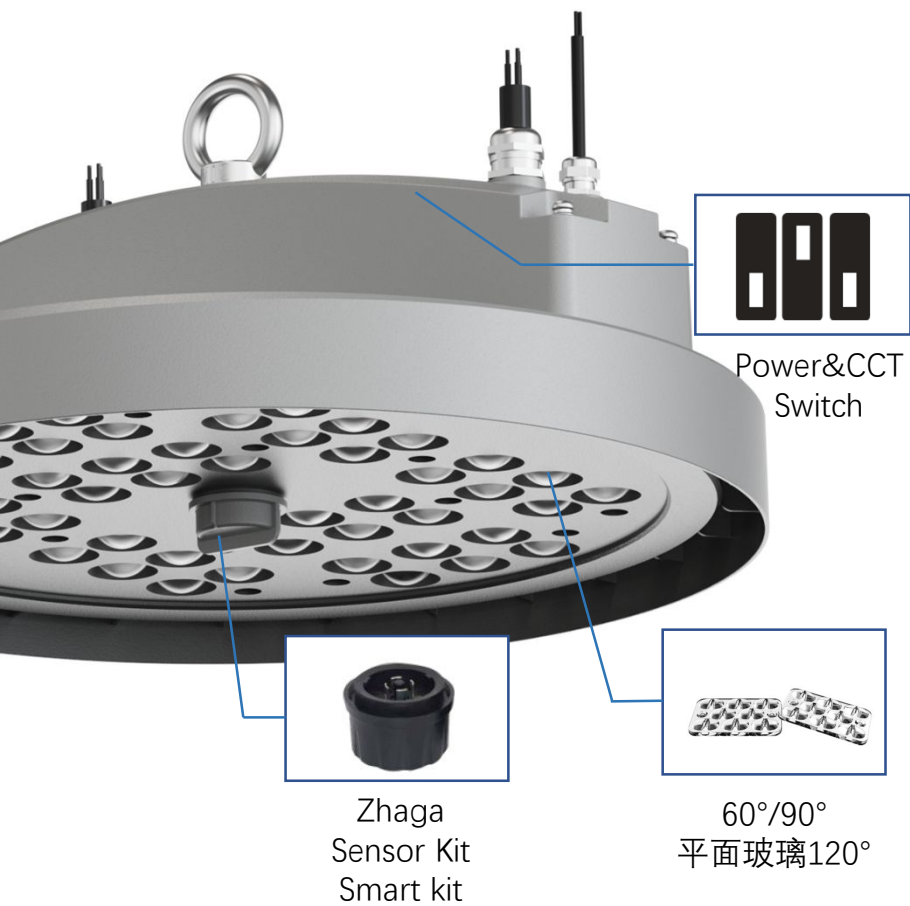

## Dimension

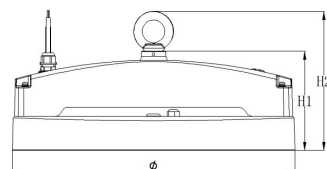

Power	D	H1	H2
190W	Φ420mm	140mm	190mm

## Installation

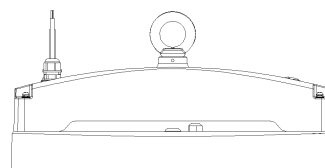

Rope Hanging

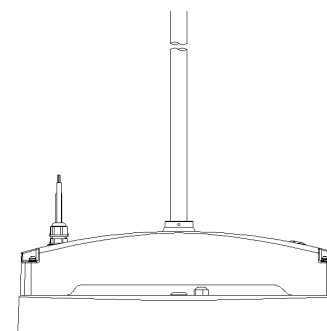

Pendant

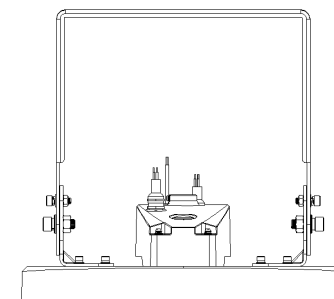

Braket

## Optical

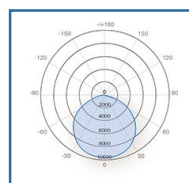

120°

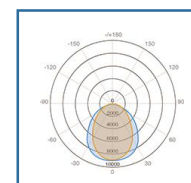

90°

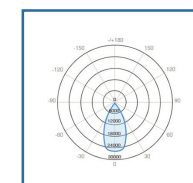

60°